



DIMENSIONS - composants système SYMA

Informations concernant les dimensions des composants système SYMA avec dimensions pour la préparation graphique

SYMA - Comptoir / article - 136

Vue de face

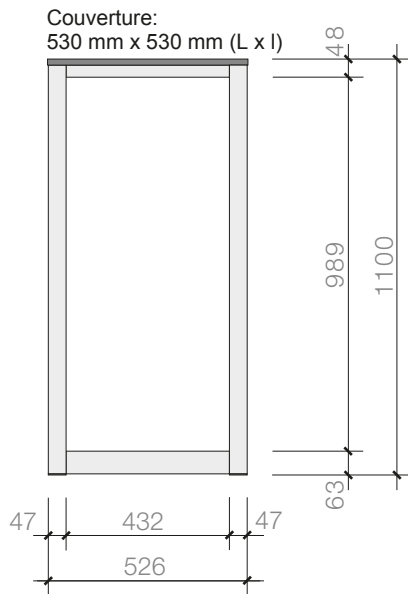

Graphique - cote

447 x 1005 mm

Vue latérale

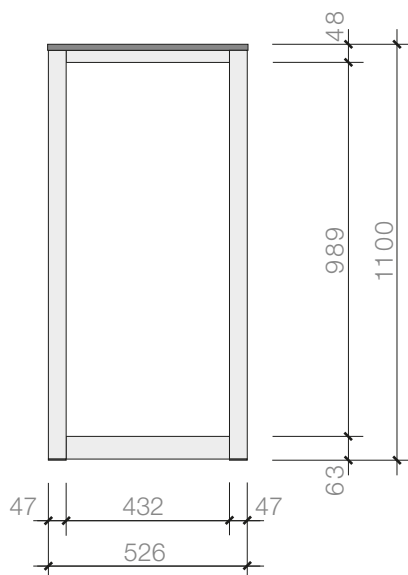

447 x 1005 mm